

WORK SHARP[®]
KNIFE & TOOL SHARPENER
KEN UNION EDITION



WSKTS-KO USER GUIDE

WorkSharpTools.com

CAUTION To reduce the risk of injury, the user must read and understand this instruction manual before using product. Save these instructions for future reference.

TABLE OF CONTENTS

Safety Information	3
Sharpening Basics	8
Getting To Know Your Tool	10
Setting Up Your Tool	12
Know Your Knife	13
Sharpening Reference Chart.....	14
Sharpening Outdoor Knives	15
Sharpening Serrated Knives	17
Sharpening Fillet Knives.....	18
Sharpening Gut Hooks	18
Sharpening Kitchen Knives	19
Sharpening Scissors.....	20
Grinding, Polishing, Deburring	21
Tool Grinding Attachment.....	22
Blade Grinding Attachment	24
Troubleshooting	26
Parts Index	27

Thank you for purchasing this tool.

Your support makes a real impact on our small business. We are confident you will be very pleased with your purchase. If that is not the case, please contact us. We know you work hard for your money and we want to provide you with a high performance, high value tool. Please keep in touch and let us know how we're doing. Until then, stay sharp out there...

Team Darex
Ashland, Oregon

SAFETY INFORMATION

You will be creating incredibly sharp knives and tools with this sharpener.
Please handle them with care. Use caution to avoid cutting yourself.



GENERAL POWER TOOL SAFETY WARNINGS

⚠ WARNING! Read all safety warnings and all instructions. Failure to follow the warnings and instructions may result in electric shock, fire and/or serious injury.



Save all warnings and instructions for future reference. The term “power tool” in the warnings refers to your mains-operated (corded) power tool or battery-operated (cordless) power tool.

⚠ WARNING! CHOKING HAZARD!

Small Parts - Not for children under 3-yrs.

SAVE THESE INSTRUCTIONS

1) Work area safety

- a) Keep work area clean and well lit. Cluttered or dark areas invite accidents.
- b) Do not operate power tool in explosive atmospheres, such as in the presence of flammable liquids, gases or dust. Power tools create sparks which may ignite the dust or fumes.
- c) Keep children and bystanders away while operating a power tool. Distractions can cause you to lose control.



2) Electrical safety

- a) Power tool plugs must match the outlet. Never modify the plug in any way. Do not use any adapter plugs with earthed (grounded) power tools. Unmodified plugs and matching outlets will reduce risk of electric shock.
- b) Avoid body contact with earthed or grounded surfaces such as pipes, radiators, ranges and refrigerators. There is an increased risk of electric shock if your body is earthed or grounded.
- c) Do not expose power tools to rain or wet conditions. Water entering a power tool will increase the risk of electric shock.
- d) Do not abuse the cord. Never use the cord for carrying, pulling or unplugging the power tool. Keep cord away from heat, oil, sharp edges or moving parts. Damaged or entangled cords increase the risk of electric shock.
- e) When operating a power tool outdoors, use an extension cord suitable for outdoor use. Use of a cord suitable for outdoor use reduces the risk of electric shock.
- f) If operating a power tool in a damp location is unavoidable, use a residual current device (RCD) protected supply. Use of an RCD reduces the risk of electric shock.

3) Personal safety

- a) Stay alert, watch what you are doing and use common sense when operating a power tool. Do not use a power tool while you are tired or under

the influence of drugs, alcohol or medication. A moment of inattention while operating power tool may result in serious personal injury.

- b) Use personal protective equipment. Always wear eye protection. Safety equipment such as dust mask, non-skid safety shoes, hard hat, or hearing protection used for appropriate conditions will reduce personal injuries.
- c) Prevent unintentional starting. Ensure the switch is in the off-position before connecting to power source or battery pack, picking up or carrying the tool. Carrying power tools with your finger on the switch or energizing power tools that have the switch on invites accidents.
- d) Remove any adjusting key or wrench before turning the power tool on. A wrench or a key left attached to a rotating part of the power tool may result in personal injury.
- e) Do not overreach. Keep proper footing and balance at all times. This enables better control of the power tool in unexpected situations.
- f) Dress properly. Do not wear loose clothing or jewelry. Keep your hair, clothing and gloves away from moving parts. Loose clothes, jewelry or long hair can be caught in moving parts. Air vents often cover moving parts and should also be avoided.
- g) If devices are provided for the connection of dust extraction and collection facilities, ensure these are connected and properly used. Use of dust collection can reduce dust-related hazards.



4) Power tool use and care

- a) Do not force the power tool. Use the correct power tool for your application. The correct power tool will do the job better and safer at the rate for which it was designed.
- b) Do not use the power tool if the switch does not turn it on and off. Any power tool that cannot be controlled with the switch is dangerous and must be repaired.
- c) Disconnect the plug from the power source before making any adjustments, changing accessories, or storing power tools. Such preventative safety measures reduce the risk of starting the power tool accidentally.
- d) Store idle power tools out of the reach of children and do not allow persons unfamiliar with the power tool or these instructions to operate the power tool. Power tools are dangerous in the hands of untrained users.
- e) Maintain power tools. Check for misalignment or binding of moving parts, breakage of parts and any other condition that may affect the power tool's operation. If damaged, have the power tool repaired before use. Many accidents are caused by poorly maintained power tools.
- f) Keep cutting tools sharp and clean. Properly maintained cutting tools with sharp cutting edges are less likely to bind and are easier to control.
- g) Use the power tool, accessories and belts etc., in accordance with these instructions, taking into account the working conditions and the work to be performed. Use of the power tool for operations different from those intended could result in a hazardous situation.

5) Service

- ⚠ Have your power tool serviced by a qualified repair person using only identical replacement parts. This will ensure that the safety of the power tool is maintained.

Darex, LLC
210 E. Hersey St.
Ashland OR 97520
USA

Tel.: 1 (800) 597-6170
Fax.: 1 (541) 552-1377
E-mail: info@darex.com
Internet: www.worksharptools.com

- Do not dispose of electrical products with household waste. Waste electrical products should not be disposed of with household waste. Please recycle where facilities exist. Check with your local authority or retailer for recycling advice.
- To replace a damaged power supply cord (Type Y), your power tool must be returned to the Service Center.



SPECIFIC SAFETY RULES

⚠ **WARNING!** ALWAYS use proper safety glasses. Everyday eyeglasses are NOT safety glasses. Also use face or dust mask if operation is dusty. ALWAYS WEAR CERTIFIED SAFETY EQUIPMENT.



•
⚠ **WARNING** Use of this tool can generate and/or disperse dust, which may cause serious and permanent respiratory or other injury. Always use NIOSH/ OSHA approved respiratory protection appropriate for the dust exposure. Direct particles away from face and body.

⚠ **CAUTION:** Wear appropriate hearing protection during use. Under some conditions and duration of use, noise from this product may contribute to hearing loss.

- Hold tool by insulated gripping surfaces when performing an operation where the abrasive belt may contact hidden wiring or its own cord. Contact with a "live" wire will make exposed metal parts of the tool "live" and shock the operator.
- Always hold tool firmly.
- Use clamps or another practical way to secure and support the work piece to a stable platform. Holding the work by hand or against your body leaves it unstable and may lead to loss of control.
- Avoid prolonged contact with dust from power sanding, sawing, grinding, drilling, and other construction activities. Wear protective clothing and wash exposed areas with soap and water. Allowing dust to get into your mouth, eyes, or lie on the skin may promote absorption of harmful chemicals.

SAFETY GUIDELINES — DEFINITIONS

It is important for you to read and understand this manual. The information it contains relates to protecting YOUR SAFETY and PREVENTING PROBLEMS. The symbols below are used to help you recognize this information:





⚠ DANGER: Indicates an imminently hazardous situation which, if not avoided, will result in death or serious injury.

⚠ WARNING: Indicates a potentially hazardous situation which, if not avoided, could result in death or serious injury.

⚠ CAUTION: Indicates a potentially hazardous situation which, if not avoided, may result in minor or moderate injury.

CAUTION: Used without the safety alert symbol (⚠) indicates a potentially hazardous situation which, if not avoided, may result in property damage.

The label on your tool may include the following symbols.

- | | | | |
|----------------------------------------------------------------------------------------|-----------------------|-----------------------------------------------------------------------------------------|---------------------------------------------|
| V | Volt | A | amperes |
| Hz..... | Hertz | W | watts |
| min | minutes |  | alternating current |
|  | direct current | n _o | no load speed |
|  | Class II Construction |  | earthing terminal |
|  | safety alert symbol | rpm..... | revolutions or
reciprocations per minute |

MOTOR

Be sure your power supply agrees with nameplate marking. 110 Volts AC only means your tool will operate on standard 60 Hz household power. Do not operate AC tools on DC. A rating of 110 volts AC/DC means that your tool will operate on standard 60 Hz AC or DC power. This information is printed on the nameplate. Lower voltage will cause loss of power and can result in over-heating.

EXTENSION CORDS

When using an extension cord, be sure to use one heavy enough to carry the current your product will draw. An undersized cord will cause a drop in line voltage resulting in loss of power and overheating. The following table shows the correct size to use depending on cord length and nameplate ampere rating. If in doubt, use the next heavier gauge. The smaller the gauge number, the heavier the cord.

SAVE THESE INSTRUCTIONS

Minimum Gauge for Cord Sets					
Volt		Total Length of Cord in Feet			
120V		0 - 25 (0-7.6 m)	26-50- (7.6-15.2 m)	51-100 (15.2-30.4 m)	101-150 (30.4-45.7 m)
230V		0 - 50 (0-15.2 m)	51-100 (15.2-30.4 m)	101-200 (30.4-60.9 m)	201-300 (60.9-91.4 m)
Ampere Rating		American Wire Gauge			
More Than	Not More Than				
0	6	18	16	16	14
6	10	18	16	14	12
10	12	16	16	14	12
12	16	14	12	Not Recommended	

INTENDED USES:

- Grinding, Sharpening and Honing applications on knives and tools.
- Light duty grinding in metal.
- Only for use with consumer applications.
- Tool should only be used with sharpening cassette or optional Work Sharp Ken Onion attachment installed.

UNINTENDED USES:

- Industrial or commercial grinding or sharpening applications.
- Extended, continuous heavy duty use.

SHARPENING BASICS:

WHAT EDGE ANGLE AND WHY?

Our recommendations (found in Section 4) are based on our extensive testing and driven by three primary factors: 1) Optimizing the edge angle for the intended purpose of the knife. 2) Optimizing edge retention for the knife's purpose. 3) Speed of sharpening process.

WHY IS A CONVEX EDGE SUPERIOR?

Our blade use and sharpness testing have taught us that a convex edge is a superior edge. The smooth radius edge type does not have 'shoulders' like a flat grind and therefore has less friction or resistance when cutting. A convex edge provides more steel behind the edge to support it, so the edge stays sharper longer. Lastly, our convex method thins the bevel when you sharpen the blade, while flat ground blades get thicker and thicker as you re-sharpen.

THE SHARPENING PROCESS

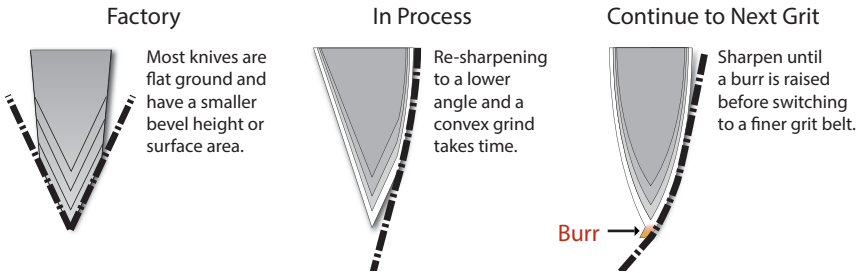

ANGLE CHANGES - WHAT TO EXPECT WITH A DECREASED ANGLE:

Duration: If you are sharpening a knife to an angle lower than the factory grind (example: factory 25° sharpening to a 15°), you should expect this process to take longer. This is due to the amount of material being removed to 'thin' the edge. Expect this reduced angle edge to be more prone to damage and edge rolling.

Bevel height: You should also expect the look of your edge to change if you are decreasing the edge angle. The height of the bevel will increase as the edge angle is reduced and create more surface area. This also increases sharpening time since the surface area of the blade being sharpened is higher.

SHARPENING BASICS (CONT.)

DEFINITIONS OF SHARP:

- **Toothy Sharp:** This is a sharp edge that has micro serrations at the cutting edge and is considered a 'toothy' edge since it bites into material. This is the ideal knife edge for general kitchen use and a working edge on a pocket knife for tasks like cutting rope or boxes.
- **Shaving Sharp:** This is a sharp edge that has been sharpened / honed / refined past a Toothy edge. The micro serrations or 'teeth' have been honed away to reveal a smooth keen edge. This is the ideal edge for field dressing animals or cutting raw meat in the kitchen.
- **Shiny Sharp:** This is a sharp edge that has been honed / stropped past a Shaving Sharp edge. This lower angle edge has a mirror reflective bevel that has little to no abrasive scratches in the surface finish of the blade and is the ultimate edge. No bleeding please!

The fastest way to a sharp edge: **Toothy Sharp**

- **Outdoor Knife:** Angle = 25° | Speed = Low/Med
 - X65: 6-10 strokes, then X22 (2 strokes)
- **Kitchen Knife:** Angle = 20° | Speed = Low
 - X65: 4-8 strokes, then X22 (2 strokes)

For a more refined cutting edge: **Shaving Sharp**

- **Outdoor Knife:** Angle = 25° | Speed = Low/Med
 - X65: 6-10 strokes, then X4 (10 strokes)
- **Kitchen Knife:** Angle = 20° | Speed = Low
 - X65: 4-8 strokes, then X4 (10 strokes)

For the ultimate cutting edge: **Shiny Sharp**

- **Outdoor Knife:** Angle = 22.5° | Speed = Low/Med
 - X65, then X22, then X4 (10 strokes each)
- **Kitchen Knife:** Angle = 17.5° | Speed = Low
 - X65, X22, and X4 (10 strokes each)

NOTE: Stroke count is for each side of the blade.

1 GETTING TO KNOW YOUR TOOL

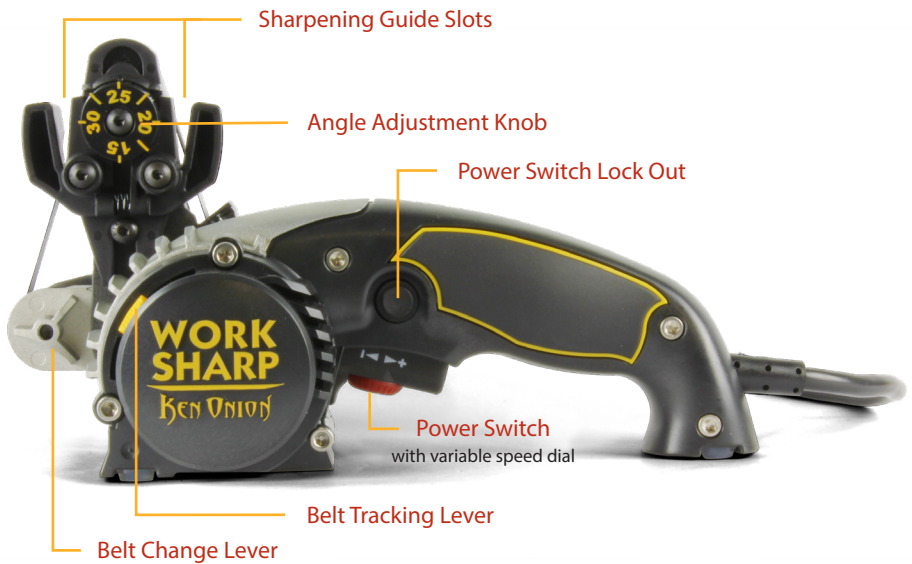

Not Pictured: Bench Mount Fastener (1/4" x 20)

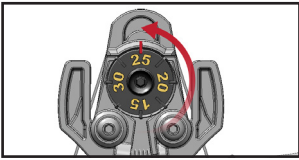

KNIFE SHARPENING GUIDE ADJUSTMENT

15° - 30° in 1° increments. The dial indicates the angle per side. Align desired angle with the indicator line on top of guide.

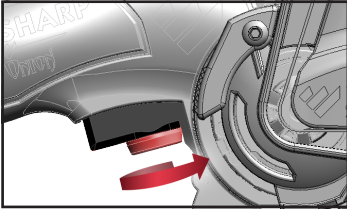

SPEED CONTROL ADJUSTMENT

Low speed (+/-) is 1200 SFM

Mid speed (+/-) is 2000 SFM

High speed (+/-) is 2800 SFM

SFM = Surface Feet per Minute

BELT INFORMATION

Belt Name		Extra Coarse	Coarse	Medium	Fine	Extra Fine
Grit		P120	X65	X22	X4	6000
Size		Norton SG	Norax 65μ	Norax 22μ	Norax 4μ	SiC 2μ
What it Sharpens		Tool Sharpening	Knife	Knife	Knife & Scissor	Gut Hooks
Uses		Knife Repair	Shape	Sharpen	Hone	Serrations

- Engineered abrasives are long lasting and will meet your sharpening needs.
- Keep clean for best performance and optimum life.
- 6000 Belt is narrow for improved gut hook sharpening.
- Belt Grits are labeled on backing (μ = micron).
- For reference, belts are equivalent to: **X65 (P220) | X22 (P1000) | X4 (P3000)**

ABRASIVE BELT WEAR

Belt discoloration is not an indicator of wear. Engineered belts expose new abrasive as they break down. Used belts may take extra strokes but will continue to remove material. These belts will keep going longer than you think. Keep using them as long as they cut.

2 | SETTING UP YOUR TOOL

Slide guide onto cassette (A)
Snap into place. Pull firmly to release.

Cassette Lock Lever (B)
Push & hold to rotate cassette from sharpening to grind mode.

Edge Guide: Pull & Rotate (C)
Clockwise to use, Counter-clockwise to parked position.

Bench Mounting (D)
Use 1/4" 20 fastener to secure tool.

Belt Change Lever (E)
Lift to reduce belt tension during belt changes.

Belt Change:

Lift & hold Belt Change Lever to remove belt. Route belt around all 3 pulleys, then release the lever. Be sure belt is within pulley flanges. Lay tool onto its side for easier belt changes.

Belt Tracking Lever

Push lever inward, then slide up or down to track belt onto the center of the top pulley (factory set at center).

Trigger Lock

Pull trigger & push button in to lock "on" position. Pull trigger to release. Not intended for use when knife sharpening, use for grinding applications only.

Sharpening Guide:

Rotate knob to select angle. Align number with mark on top. The dial indicates the angle per side.

Removing the Sharpening Cassette:

1. Remove belt from sharpening cassette.
2. Push and hold lock lever and rotate cassette to position shown.
3. Dismount cassette by pulling outward.
4. Locate this same position to re-install sharpening cassette or attachments.

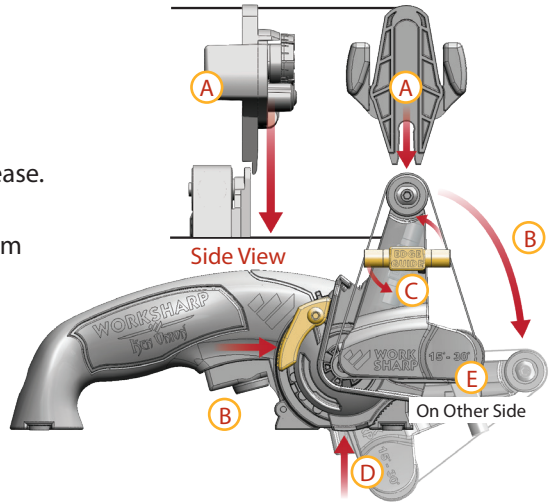

Sharpening

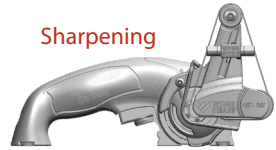

Grinding

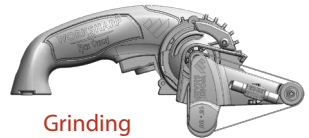

Remove



3 | KNOW YOUR KNIFE

KITCHEN KNIFE

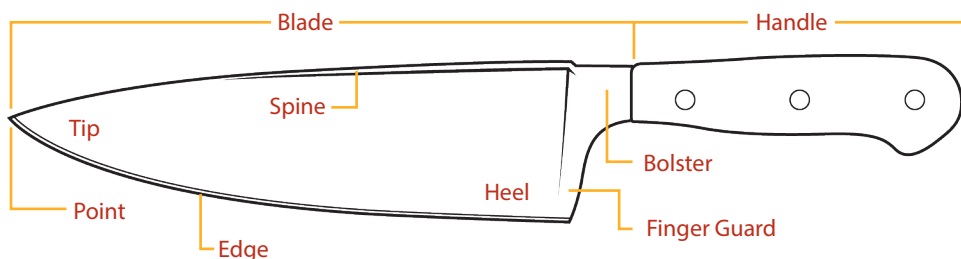

OUTDOOR KNIFE

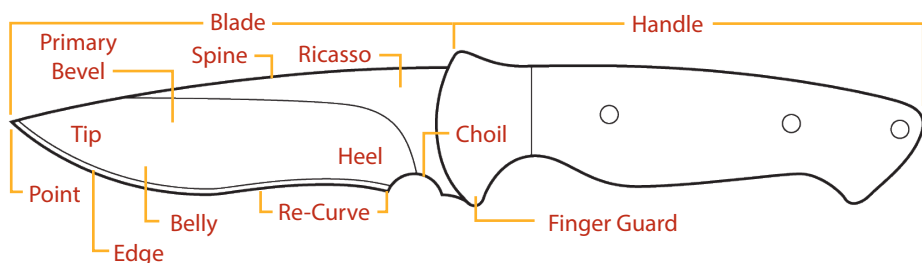

BLADE TYPES

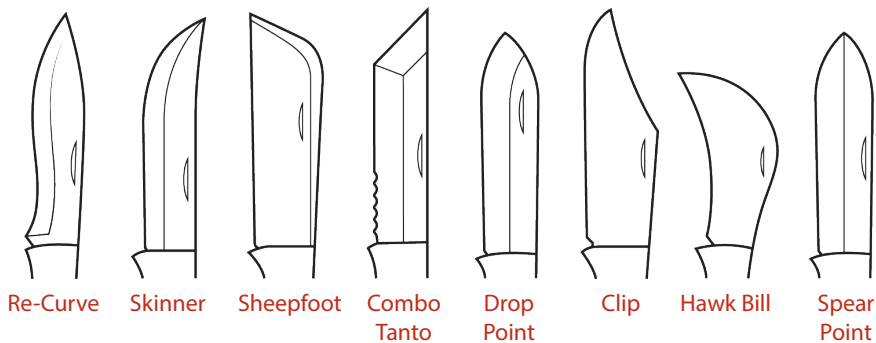

4 SHARPENING REFERENCE CHART

KITCHEN KNIVES

Pull rate: 1"/sec • Use Edge Guide

	Angle	Speed	X65	X22	X4	6000
Western	20°	L	4-8	4-8	10	0
Asian	16°	L	0	4-8	10	0
Paring	20°	L	4-8	4-8	10	0
Cleaver	30°	H	4-8	2-8	0	0
Bread	X	L	0	0	0	2

Number of strokes per side.

OUTDOOR KNIVES

Pull rate: 1"/sec • No Edge Guide

	Angle	Speed	X65	X22	X4	6000
Pocket	25°	L/M	6-10	6-10	10	0
Hunting	25°	L/M	6-10	6-10	10	0
Fillet	20°	L/M	6-10	6-10	10	0
Serrated	X	L	0	0	0	2
Gut Hook	X	M	0	0	0	2

Number of strokes per side.

BEST TECHNIQUES:

- Resharpener using X4 only.
- Follow the curve of the knife when sharpening for best results.
- Use the Edge Guide on long or flexible blades when possible.
- Masking tape can protect blade from scratching during sharpening.
- Use a practice knife to learn.

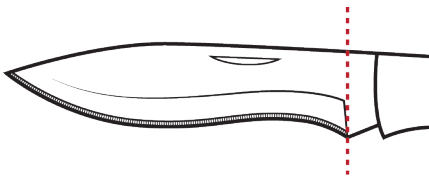

Position belt at the very start of the edge with motor off.

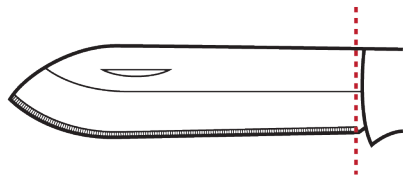

Place blade in guide then simultaneously power up and pull the blade.

5

SHARPENING OUTDOOR KNIVES

Reference Section 4 and the Sharpening Reference Chart for recommended angle settings, belt selection, stroke count, speed and choice of edge type.

1. PLACE THE BLADE IN THE GUIDE

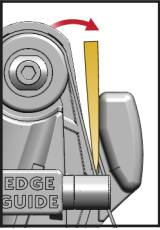

With power off, insert blade into right side of sharpening guide all the way to the start of the edge.

Place knife to bottom and outside edge of guide slot.

Do not put pressure onto / into the sharpening guide. It is intended to provide a reference point for blade position. Only use light pressure (weight of the blade) when using the sharpening guide to yield best results.

n Best Techniques:

When and why to use the Edge Guide:

- Most pocket / outdoor knives are best sharpened without using the Edge-Guide since they often have thumb studs or belt clips that can obstruct full blade insertion.
- It is helpful to support and guide long blades (fillet knives and machetes) through the sharpening process.

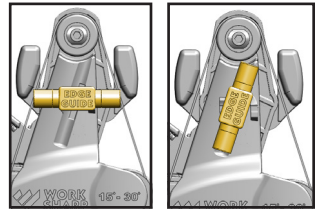

Pull and Rotate

2. POWER ON AND PULL THE KNIFE

With power off and blade placed in the guide, simultaneously squeeze the power switch and pull blade steadily through the guide (1" per second).

Follow the curve of the blade as you pull through the guide. Keep cutting edge perpendicular to the belt for best and most consistent results.

Use only the weight of the blade – do not press down into / onto guide. Hover the blade and let the tool do the work for best results.

Guide will 'tip over' if too much outer pressure is applied.



Power off as you come to the point, while the blade is still supported by the belt.

3. REPEAT AND FEEL FOR BURR

Continue sharpening on right side of guide.
Check for a burr every 2-3 strokes (see picture).

Sharpen until a burr is created along the entire length of the edge.

If burr is not yet raised, See *"Knife not getting sharp"* in Troubleshooting section.

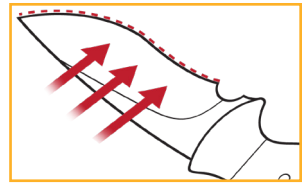

Check for a burr by brushing fingers across/away from the blade edge.

Repeat same number of strokes on other side of blade / sharpening guide.

Once the edge is shaped / formed, continue with finer grit belts using alternating strokes. Alternating strokes removes the burr and refines the edge faster.

See Sharpening Reference Chart in Section 4 for recommended belt use and stroke count based on the edge you want (Toothy, Shaving, Shiny).

n Best Techniques: (Avoid rounding the tip)

Maintain factory blade profile / shape:

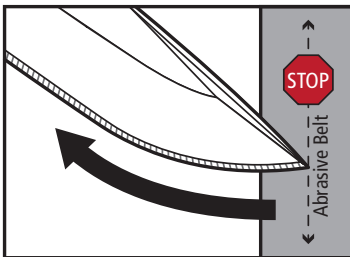

Follow the curve of the blade so the edge remains perpendicular to the belt. Turn off the power as you come to the point.

Use this technique for these blade types:

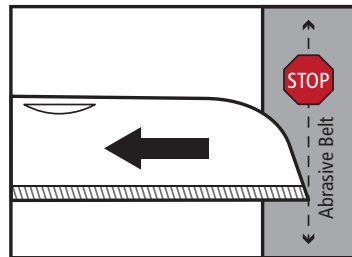
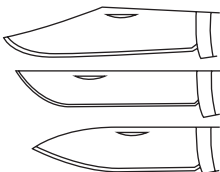

Pull straight through the guide and stop on the middle of the belt. Do not lift the blade handle. Turn power off as knife point contacts belt.

Use this technique for these blade types:

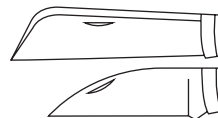

6 SHARPENING SERRATED KNIVES

Most serrated knives have a flat side and a bevel side on the blade; Sharpen only the flat side.



Flat Side



Beveled Side

Only use the finest grit 6000 belt (purple, narrow) for serrated sharpening.

Place flat side of blade at the bolster / handle against the fine grit abrasive belt. Set to low speed and squeeze the power switch and pull knife steadily across the belt from bolster to tip. An 8" blade should take 8 seconds.

Repeat until no burr remains on the flat side of the blade and serration 'teeth' are sharp.

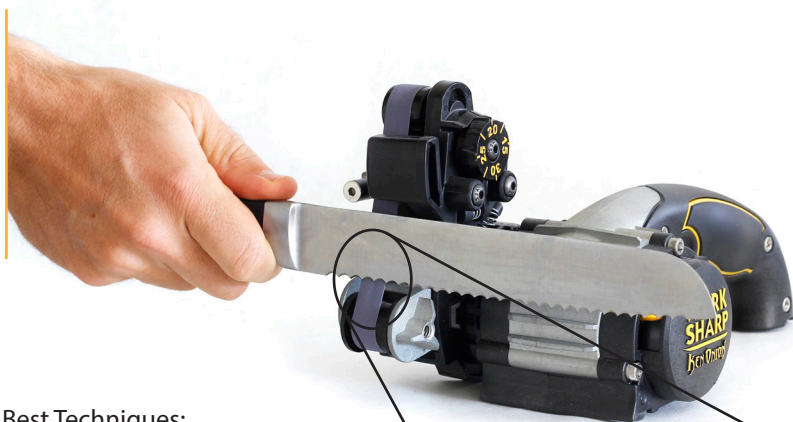

n Best Techniques:

Serrated knives can be sharpened with or without the Knife Sharpening Guide installed depending on height of serrated knife.

Only place serrated blades on downhill - right side of belt. Otherwise you risk cutting the belt.

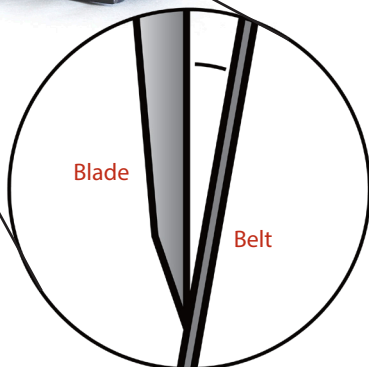

7 SHARPENING FILET KNIVES

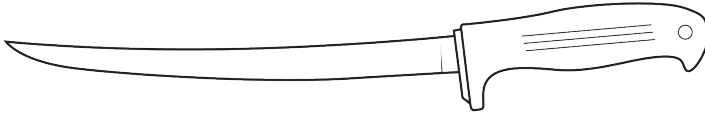

Reference the Sharpening Reference Chart in Section 4 for recommended angle settings, belt selection and speed. Otherwise sharpening a filet knife is the same as other knives.

Use the Edge Guide to help support these long, flexible blades during sharpening to ensure a consistent sharpening along the entire edge.

Use very light pressure in the sharpening guide so the blade does not flex.



8 SHARPENING GUT HOOKS

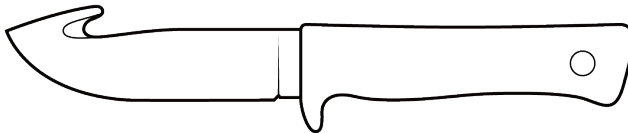

Only use finest grit 6000 belt (purple, narrow) for sharpening gut hooks.

Place curve of gut hook over the belt on downhill side; allow belt to conform to blade's curve. Squeeze power switch; hone 2 to 4 seconds. Repeat on other side.



n Best Techniques:

Only place gut hook on downhill - right side of belt. Otherwise you risk cutting the belt.

9 SHARPENING KITCHEN KNIVES

Reference the Sharpening Reference Chart in Section 4 for recommended angle settings, belt selection and speed. Otherwise sharpening a kitchen knife is the same as other knives.

Most kitchen knives should be sharpened with the Edge-Guide.

No finger guard



Finger guard



1. PLACE THE BLADE IN THE GUIDE

With power off, insert blade into right side of sharpening guide all the way to the beginning of the edge or finger guard.

Place knife to bottom and outside edge of guide slot.

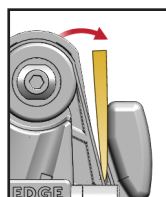

2. POWER ON AND PULL THE KNIFE

With power off and blade placed in the guide, simultaneously squeeze the power switch and pull blade steadily through the guide (1" per second).

Follow the curve of the blade as you pull through the guide. Keep cutting edge perpendicular to the belt for best and most consistent results.

Use only the weight of the blade – do not press down into / onto guide. Hover the blade and let the tool do the work for best results.

Guide will 'tip over' if too much outer pressure is applied.

Continue sharpening on right side of guide until a burr is created along the entire length of the edge.

Repeat same number of strokes on other side of blade / sharpening guide.

Continue sharpening with finer grit belts using alternating strokes. Alternating strokes removes the burr and refine the edge faster.



10 SHARPENING SCISSORS

Sharpen only the beveled side of your scissors. Marking the beveled side with a black marker will make it easier to see when the cutting edge has been sharpened.

Use the 6000 grit belt at medium to hone or touch-up scissors.

Use the X22 belt at medium speed to sharpen damaged scissors.

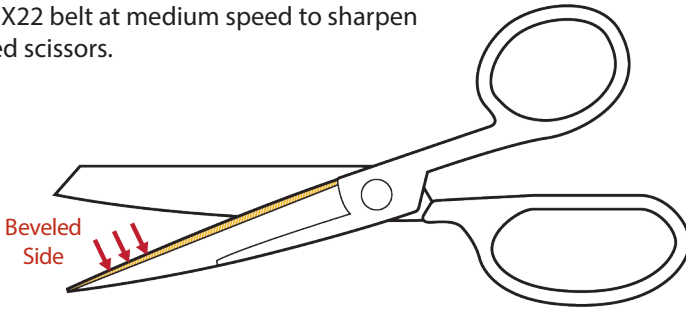

Once scissor blade is properly placed in Sharpening Guide, squeeze power switch and simultaneously pull the scissor blade steadily through the guide.

Repeat 1-2 more times or until marker is removed from cutting edge.

Repeat on other scissor blade.

Test scissors for sharpness. Continue sharpening as needed.

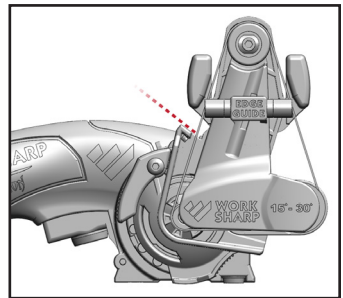

11 GRINDING, POLISHING, DEBURRING

Remove Sharpening Guide. Pull up firmly.

Ensure the Edge Guide is in the parked position and that the Knife Sharpening Guide has been removed before grinding.

Push Cassette Lock Release Lever to rotate cassette to grind mode.

Use the P120 belt and high speed for light sharpening and grinding tasks.

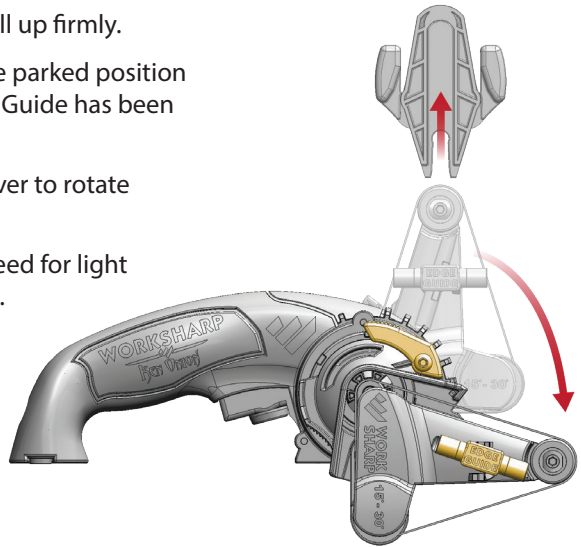

NOTE: Tools such as these do not require sharpening to a precise angle; just let the belt conform to the edge of the tool. It will take longer to restore an edge to severely damaged tools.

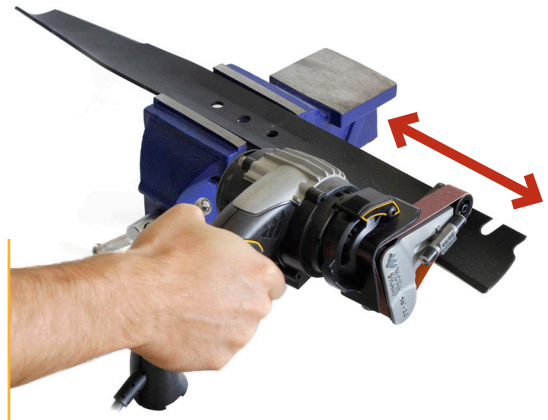

n Best Techniques

- Always clamp or fixture work piece before grinding for optimum safety.
- Let the tool do the work. Do not overload the tool during grinding. Abrasive selection and belt speed are already optimized.
- Only sharpen tools on the right hand / downhill side of the belt.
- Tool Grinding Attachment available for heavier grinding tasks (see Section 12).

12 TOOL GRINDING ATTACHMENT

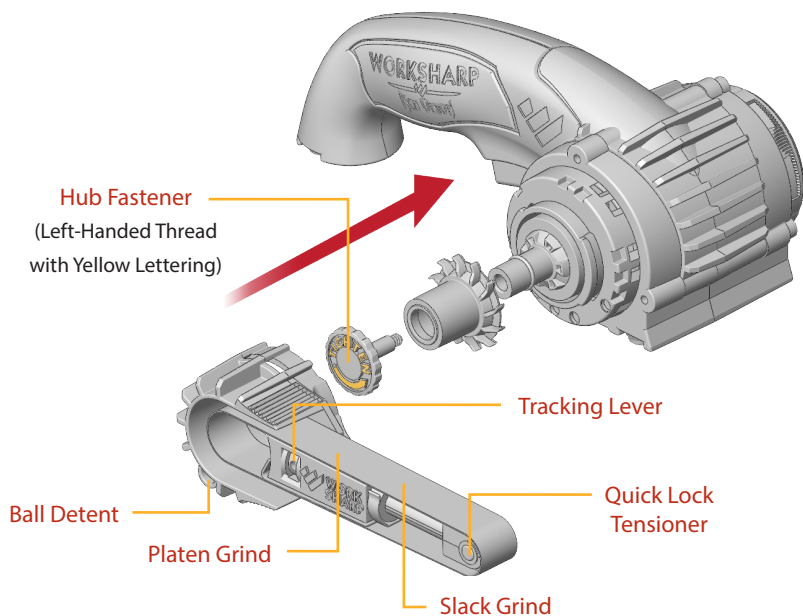

INSTALLATION

Push lock release lever and rotate knife sharpening cassette to position shown, pull outward to remove cassette.

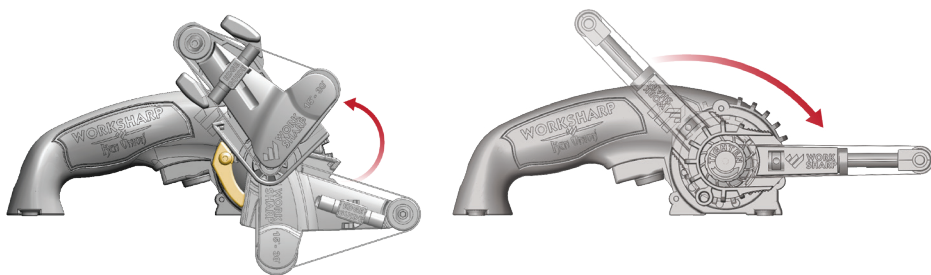

1. Install pulley drive hub onto tool using provided Left-Hand Thread Hub Fastener – turn LEFT to tighten and RIGHT to loosen, do not over-tighten fastener. Be sure the drive pulley is properly aligned onto the keyed motor shaft.
2. Install metal Tool Grinding Attachment by pressing inward and rotating forward.
3. Push in and turn tensioner to install / uninstall belt. Use tracking lever to center belt on pulley.

Sharpen Mower Blade

Use high speed and low pressure.



Deburr Pipe



BELT INFORMATION:

	P60
	Norton ZA
	Grinding

Belt Selection and Education:
P60 grit Zirconia Alumina belt from Norton is designed and intended for grinding tasks in metal.

NOTE: Never use this abrasive for knife sharpening – it is too coarse.

n Best Techniques:

- Remember – Lefty Tightly / Righty Loosey on Hub Fastener.
- Keep tool and attachment clean for optimum life and performance.
- Avoid overheating tool.
 - Allow tool to cool to room temperature between rated operating periods.
- Speed Setting: Use at full speed for optimum performance.
- Always secure work piece and wear eye protection when grinding.

13 | BLADE GRINDING ATTACHMENT

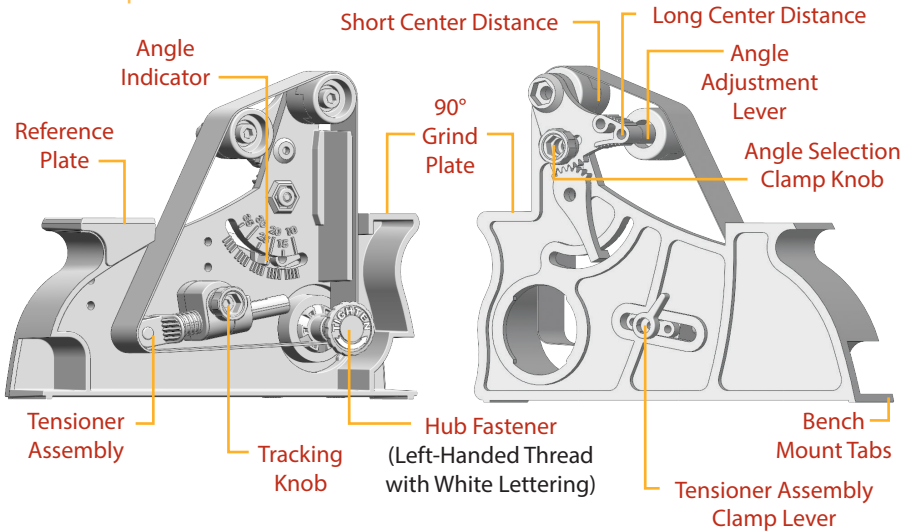

BELT INFORMATION:

For reference, belts are equivalent to: X65 (P220) | X22 (P1000) | X4 (P3000)

Grit	P120	X65	X22	X4	12000MM
Color	Red	Brown	Light Grey	White	Grey
Size	Norton SG	Norax 65µ	Norax 22µ	Norax 4µ	SiC 1µ
Use	Repair	Shape	Sharpen	Hone	Strop

INSTALLATION

Push lock release lever & rotate knife sharpening cassette to remove cassette (see Section 12).

Install Blade Grinding Attachment by aligning the chassis to the keyed 'on / off' position then rotate into 'sharpening position'.

Install Hub Fastener with white lettering onto drive shaft. Turn LEFT to tighten, RIGHT to loosen.

Optional: Use a clamp to secure to work bench.

Push in and turn tensioner clockwise to install / uninstall belt.

Use tracking knob to center belt on pulley.



1. Choose either short or long center location for pulley depending on preference.
2. Select desired sharpening angle by moving the Angle Adjustment Lever.
3. Tighten Angle Selection Clamp Knob to secure selected angle.
4. Mount the belt of your choice based on task at hand (see chart left).
5. Turn on power to medium speed and press switch lock out button.
6. Ensure belt is tracking properly so it is centered on the pulleys.
7. Place blade flat onto reference plate (*see fig. 1*).
8. While keeping blade flat, move up onto belt surface and place the heel of the blade edge onto the abrasive. Use very light pressure on belt (3/16" deflection).
9. Move blade flat across abrasive (1" per second) and stop the tip on the middle of the belt. Then pull blade away from the belt.
10. Continue until a burr is raised along entire edge (count strokes).
11. Repeat same number of strokes on other side of blade.
12. Continue up the grit scale until desired sharpness is achieved.
13. Ensure tracking and tension is properly set when you change belts.

n Best Techniques:

Be mindful that accommodations will need to be made for every blade such as thumb studs, pocket clips, blade profile or handle design. Test run the blade through the process on both bevels without power first to ensure accommodations can be made before sharpening.

Do not over tension belt or it may negatively affect belt tracking or motor performance.

14 | TROUBLESHOOTING

KNIFE NOT GETTING SHARP?

- More strokes - Grind all the way to the edge. Continue until a burr is raised. Then progress to a finer belt.
- Higher Speed - Slow belt speeds may not be removing enough material.
- Coarser Belt - Coarser grit belts will remove material more aggressively.

a) Problem: The tips of my knives are becoming rounded. See Section 5.

Solution 1: Stopping with the point still supported by the belt while powering down the tool will reduce tip rounding.

Solution 2: Keep the blade edge perpendicular to the belt. To reduce tip rounding, follow the curve of the blade.

b) Problem: The belt is cutting into the sharpening guide or edge guide.

Solution 1: Use the belt tracking lever to re-adjust the belt position to center of the pulley.

c) Problem: How do I feel for a burr at the cutting edge to know when to proceed to a finer belt?

Solution 1: Slide your finger perpendicular and away from the cutting edge. The burr will feel like a small 'ridge' or 'wire' at the edge.

d) Problem: My knives are cutting through my edge guide.

Solution 1: Use much lighter pressure on the Edge Guide. Using only the weight of the blade provides best results.

e) Problem: How do I avoid scratch marks on the side of my blade?

Solution 1: Run a piece of masking tape along the blade, exposing just the bevel.

n Best Techniques:

Only use P120 on blades with edge damage, thick / wide edges or very hard blade steels (D2, S30V, 154CM, etc.). This belt will remove material and raise a burr very quickly. Use sparingly and check for a burr after every stroke.

15 PARTS INDEX

ACCESSORY LIST:

Replacement Belts:

WSKTS-KO Belt Kit ($\frac{3}{4}$ " x 12" belts): WSSAKO81113

Extra Coarse P120 Grit Belt Kit ($\frac{3}{4}$ " x 12" belt): WSSAKO81117

Coarse X65 Grit Belt Kit ($\frac{3}{4}$ " x 12" belt): WSSAKO81118

Medium X22 Grit Belt Kit ($\frac{3}{4}$ " x 12" belt): WSSAKO81119

Fine X4 Grit Belt Kit ($\frac{3}{4}$ " x 12" belt): WSSAKO81120

Extra Fine 6000 Grit Belt Kit ($\frac{1}{2}$ " x 12" belt): WSSA0002705

Tool Grinding Attachment:

WSKTS-KO Tool Grinding Attachment: WSSAKO81111

WSKTS-KO Tool Grinding Belt Kit ($\frac{3}{4}$ " x 12" belts): WSSAKO81114

Blade Grinding Attachment:

WSKTS-KO Blade Grinding Attachment: WSSAKO81112

WSKTS-KO Blade Grinding Belt Kit (1" x 18" belts): WSSAKO81115

Extra Coarse P120 Grit Belt Kit (1" x 18" belts): SA0003564

Coarse X65 Grit Belt Kit (1" x 18" belts): SA0003585

Medium X22 Grit Belt Kit (1" x 18" belts): SA0003584

Fine X4 Grit Belt Kit (1" x 18" belts): SA0003565

Extra Fine 12,000 Grit Belt Kit (1" x 18" belts): SA0003566

Cloth Belt Kit (1" x 18" belts with honing and polishing compound): WSSAKO81121

Visit worksharptools.com for a full list of replacement parts.

3 YEAR WARRANTY

This sharpener is covered by Work Sharp's 3-year warranty. We stand behind and support our products – contact us if you need assistance, parts, or service.

Warranty for consumer not industrial or commercial use, excludes abrasives. Register your warranty online at WorkSharpTools.com.

QUESTIONS?

WorkSharpTools.com / 1.800.418.1439

WORK SHARP

PO BOX 730

210 E. Hersey St. Ashland,

OR 97520 USA



*Excludes
Abrasives



 **WORK SHARP®**
KNIFE & TOOL SHARPENER
KEN UNION EDITION

WORK SHARP
210 E. Hersey St.
Ashland OR 97520
USA

Tel.: 1 (800) 597-6170

Fax.: 1 (541) 552-1377

E-mail: info@darex.com

Internet: www.worksharptools.com

WORK SHARP® is a trademark of Darex, LLC.